



**BRICK & BLOCK**

*Manufacturers Since 1868*



**Concrete  
Interlocking  
Pavers**



Need help planning your home project?

Visit our Website

We work with a number of design and builder professionals who can help you design your project, estimate the materials you'll need and do the work for you.

Visit us online at [www.mcnear.com](http://www.mcnear.com) and go to the *Request a Quote* page. We'll recommend an experienced, reliable and trustworthy designer or installer to help you.

You can also find more photos and information about all our McNear product lines at [www.mcnear.com](http://www.mcnear.com).

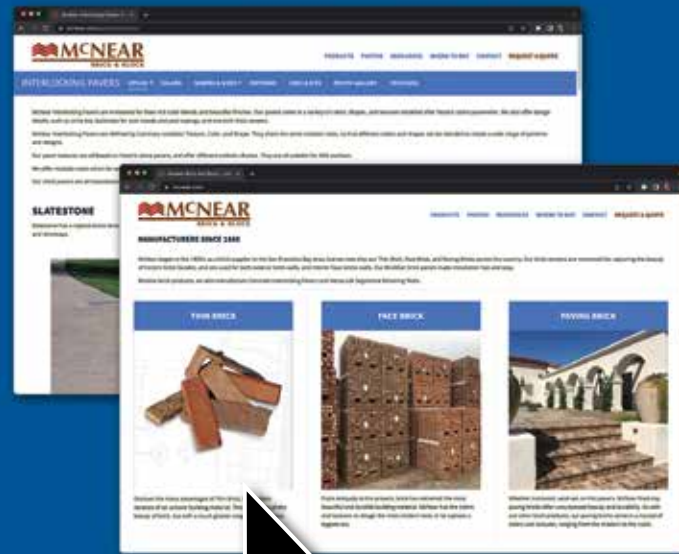

**MCNEAR**  
BRICK & BLOCK  
Manufacturers Since 1868



# Concrete Interlocking Pavers

The Romans perfected interlocking cobblestone pavements over 2000 years ago, and many of their roads are still in good shape. Today, Interlocking Pavers made from modern high-strength concrete are used in the same fashion to create beautiful and durable pavements.

McNear Interlocking Pavers are renowned for their rich color blends and beautiful finishes. Our pavers come in a myriad of colors, shapes, and stone textures, and are complemented by design details such as circle kits, pool copings, and one-inch thick veneers.

Any surface that you might consider paving can be adorned with McNear Interlocking Pavers. Common applications include driveways, patios, pathways, and pool areas. Unlike poured concrete and asphalt pavements, interlocking pavements remain flexible and create a beautiful and crack-proof surface.

Whether you prefer an Old World look or a clean, modern design, McNear Brick and Block has crafted interlocking pavers that fit your personal style.

## Table of Contents

Slatestone	2-3
Slatestone Backside	4-5
Cobblestone	6-7
Cobblestone Backside	8-9
Permeable Pavers	10-11
Belgian Cobble	12
Old County Cobblestone	13
Circle Paver Kits	14
1-Inch	15
Concrete Bullnose	16-17
Patterns	18
Specifications	19
Circle Kit Diagram	20



Slatestone,  
Color: Charcoal/Gray

Pictured on front: Cobblestone pavers in Yosemite

Visit [www.mcnear.com](http://www.mcnear.com) to see our newest products and colors.

# Slatestone



Charcoal/Gray



## Slatestone

Slatestone's smooth, layered surface will add the beauty of natural stone to your driveway, patio, or walkway. Use up to four different paver shapes to create either complex or simple designs.

Pavers can be ordered in any of our colors, but for non-stock colors, there may be minimum order requirements and/or set-up charges. Contact our office for a quote.

Please refer to pages 18-20 for information on patterns, sizes, coverage, and circle kits. Permeable Slatestone is also available; see pages 10-11.



Charcoal/Tan

## Stock Colors



Charcoal / Gray



Charcoal / Tan



Lassen



Olivine



Tierra



Yosemite

# Slatestone Backside



Charcoal/Gray

## Slatestone Backside

For those interested in a flatter paving surface than our Slatestone texture, we have a solution that has been hidden in plain sight: *Slatestone Backside*. This surface is achieved by installing Slatestone pavers upside-down, and exposing their "backsides". While the Backside surfaces are substantially flat, they are not perfectly so: each paver reflects the subtle scars and wear from our production boards' many years of use. And these pavers also go through a tumbling process that adds an additional patina of age.

*Pavers can be ordered in any of our colors, but for non-stock colors, there may be minimum order requirements and/or set-up charges. Contact our office for a quote.*

Please refer to pages 18-20 for information on patterns, sizes, coverage, and circle kits. Permeable Slatestone Backside is also available; see pages 10-11.



Charcoal/Gray

## Stock Colors



Charcoal / Gray



Charcoal / Tan



Lassen



Olivine



Tierra



Yosemite

# Cobblestone



Charcoal/Tan

## Cobblestone

With their natural appearance and traditional look and feel, *Cobblestone* pavers have been pleasing homeowners for decades. Clean lines with soft rounded edges, *Cobblestone* pavers peacefully blend into the natural beauty of any landscape.



Yosemite

*Pavers can be ordered in any of our colors, but for non-stock colors, there may be minimum order requirements and/or set-up charges. Contact our office for a quote.*

Please refer to pages 18-20 for information on patterns, sizes, coverage, and circle kits.

**Permeable Cobblestone is also available.**  
See pages 10-11.

## Stock Colors



Charcoal / Gray



Charcoal / Tan



Lassen



Olivine



Tierra



Yosemite

# Cobblestone Backside



## Cobblestone Backside

For those interested in a flatter paving surface than our Cobblestone texture, we have a solution that has been hidden in plain sight: *Cobblestone Backside*. This surface is achieved by installing Cobblestone pavers upside-down, and exposing their “backsides”. While the Backside surfaces are substantially flat, they are not perfectly so: each paver still reflects the subtle scars and wear from our production boards’ many years of use. No two pavers are identically alike.

*Pavers can be ordered in any of our colors, but for non-stock colors, there may be minimum order requirements and/or set-up charges. Contact our office for a quote.*

Please refer to pages 18-20 for information on patterns, sizes, coverage, and circle kits. Permeable Slatestone is also available; see pages 10-11

*Permeable Cobblestone Backside is also available. See pages 10-11.*



Yosemite

## Stock Colors



Charcoal / Gray



Charcoal / Tan



Lassen



Olivine



Tierra



Yosemite

# Permeable Pavers

Available in Slatestone, Cobblestone and Canyon Cobble



Permeable Cobblestone,  
Color: Charcoal/Tan



Permeable Cobblestone,  
Color: Olivine

## Heal the earth while you beautify your home

McNear Permeable Pavers are engineered to support the water cycle. They reduce storm drain runoff and filter out water-borne pollutants as rain water is returned to the earth naturally.

Our Permeable Pavers incorporate the same aesthetic and design features as our standard interlocking pavers, using multiple shapes and small gaps to preserve their natural appeal.

- Save money by reducing or eliminating your need for storm drains or catch basins
- Recharge the aquifer and help increase supplies of local drinking water
- Improve the water quality of streams and creeks
- Reduce storm water runoff and flooding problems
- Work in harmony with your home's natural vegetation and landscaping
- Worry less with pavers that are both durable and earth-friendly.



Permeable Slatestone,  
Color: Tan/Brown

Pavers can be ordered in any of our colors, but for non-stock colors, there may be minimum order requirements and/or set-up charges. Contact our office for a quote.

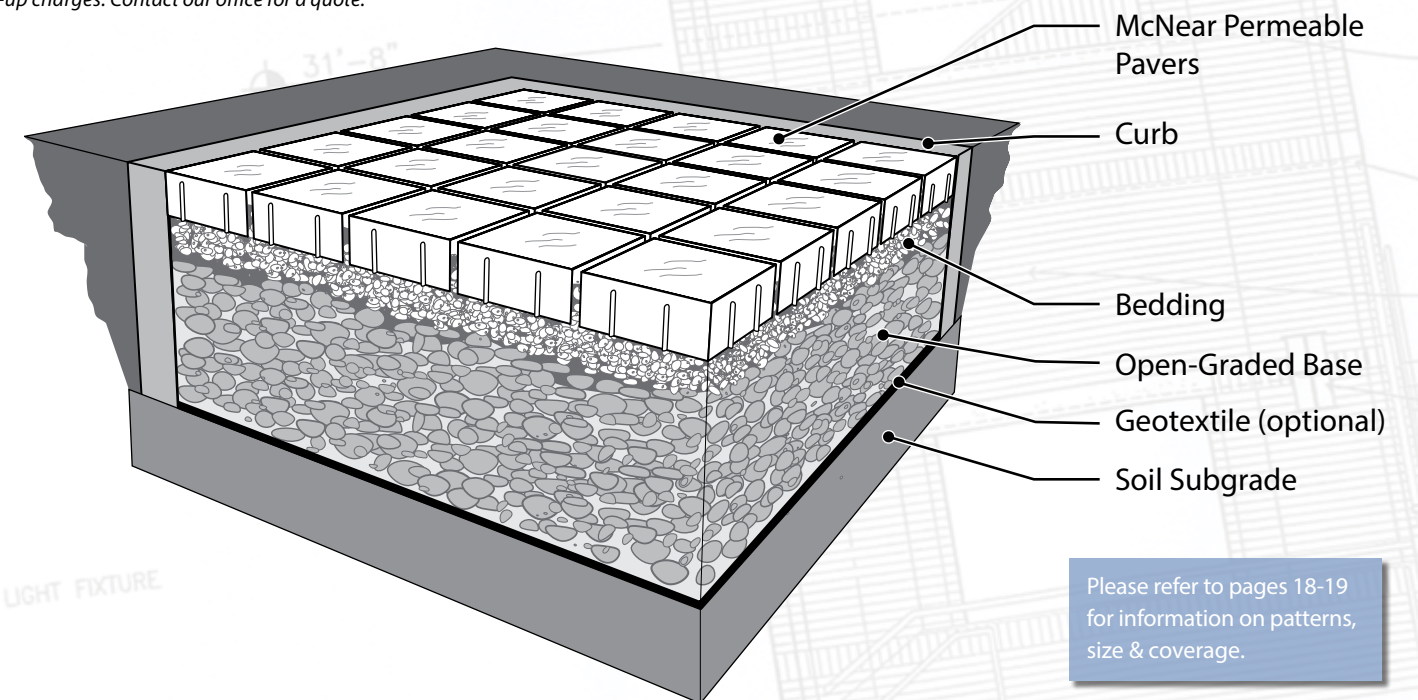

Please refer to pages 18-19 for information on patterns, size & coverage.

Permeable Pavers can be ordered in any color of Slatestone, Slatestone Backside, Cobblestone, and Cobblestone Backside, however we do not stock any Permeable Pavers, and minimum orders may apply.

SLATESTONE • SLATESTONE BACKSIDE • COBBLESTONE • COBBLESTONE BACKSIDE • PERMEABLE • BELGIAN COBBLE • OLD COUNTY COBBLE • BULLNOSE

SLATESTONE • SLATESTONE BACKSIDE • COBBLESTONE • COBBLESTONE BACKSIDE • PERMEABLE • BELGIAN COBBLE • OLD COUNTY COBBLE • BULLNOSE



## Belgian Cobble

You might not live in Europe, but you can replicate that classic Old World appeal for your home. *Belgian Cobble's* timeworn texture radiates warmth and charm, and is available in four different paver sizes.

Please refer to pages 18-20 for information on patterns, sizes, coverage, and circle kits.

Pavers can be ordered in any of our colors, but for non-stock colors, there may be minimum order requirements and/or set-up charges. Contact our office for a quote.



Charcoal / Gray



Charcoal / Tan

## Old County Cobblestone

Capture the essence of ancient cobble streets curving through scenic villages. *Old County Cobblestone* can add a touch of serenity to any style of architecture whether you prefer a rustic or modern aesthetic.

Please refer to pages 18-19 for information on patterns, size & coverage.



Charcoal / Tan



Charcoal / Gray



## Circle Paver Kits

Transform an ordinary driveway, pathway or patio into a work of art by accenting it with a circular paving stone design.

Our *Circle Paver Kits* are available in Slatestone, Cobblestone and Belgian Cobble textures.

Call for availability of specific colors.

- A. Charcoal/Tan with Belgian Cobble field pavers in Golden Tan
- B. Charcoal/Tan and Golden Tan blend with Slatestone field pavers and Concrete Bullnose in a Charcoal/Tan and Golden Tan blend
- C. Charcoal/Tan Slatestone circle pavers with Weathered Mosaic retaining wall in Shasta



Please refer to pages 18-19 for information on patterns, size & coverage.

See pages 2-5 for Slatestone pavers, pages 12-13 for Belgian Cobble pavers and page 16-17 for Concrete Bullnose. See the McNear Retaining Walls brochure for more information on Weathered Mosaic retaining walls.

## 1-Inch Pavers

McNear 1-Inch Pavers are ideal for applications where full-depth pavers are impractical. Use them to cover existing porches and stairs, and to face concrete curbs and gutters. McNear 1-Inch Pavers can be installed using either mortar or sand-set techniques.

1-Inch pavers can be ordered in any of our shapes, styles and colors, including Bullnose pieces. Custom thicknesses are also available.

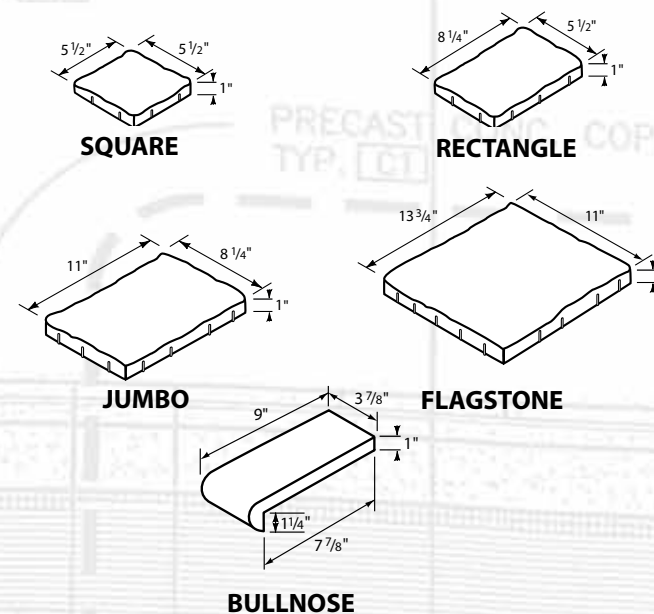

1-Inch Cobblestone, Color: Napa



1-Inch Bullnose, Color: Charcoal/Tan

# Bullnose

## Bullnose

The ideal finisher to your landscaping—our *Bullnose Pavers* complement any McNear product while adding a polished look to your stairway, driveway, pathway, or swimming pool.

Bullnose pavers are available in Classic and Weathered textures. McNear's Classic texture retains a smooth, contemporary surface. If you prefer rustic landscaping, our Weathered texture is tumbled to create a rough yet charming, time worn feel.

Charcoal / Gray (Classic)

Charcoal / Tan (Weathered)

Call for availability of specific colors.

Please refer to pages 18-19 for information on patterns, size & coverage.

See pages 2-5 for Slatestone pavers and page 14 for Slatestone Circle pavers.



# Patterns

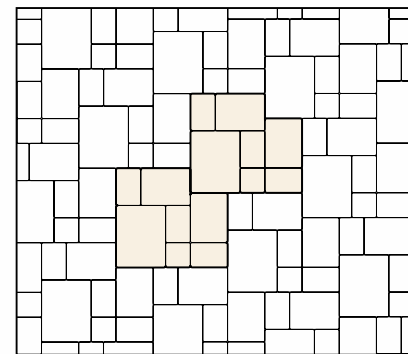

**DIAMOND VERTIGO**  
30% FLAGSTONE\*  
36% JUMBO  
27% RECTANGLE  
6% SQUARE

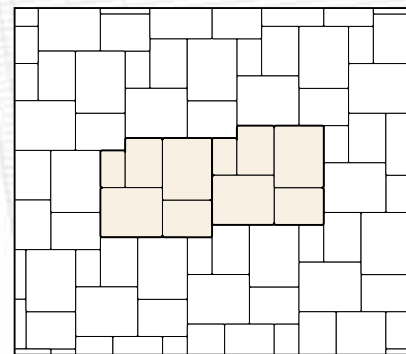

**EL DORADO**  
57% FLAGSTONE\*  
34% JUMBO  
9% RECTANGLE

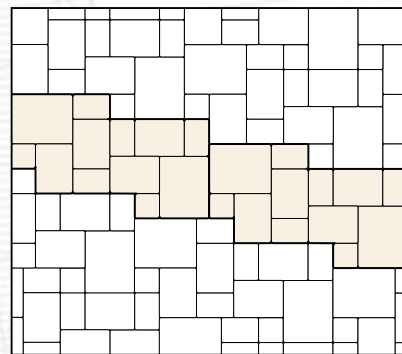

**ESCALATOR**  
33% FLAGSTONE\*  
40% JUMBO  
20% RECTANGLE  
7% SQUARE

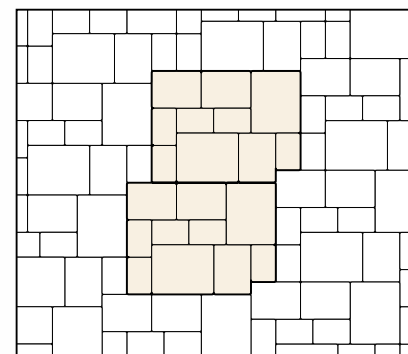

**GALANT**  
38% FLAGSTONE\*  
34% JUMBO  
28% RECTANGLE

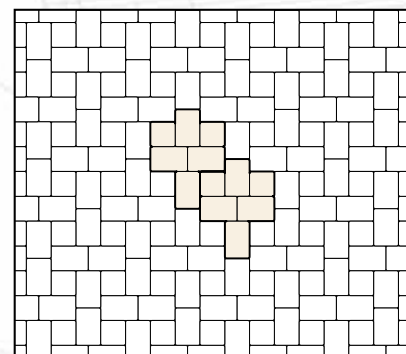

**OLD TOWN**  
75% RECTANGLE  
25% SQUARE

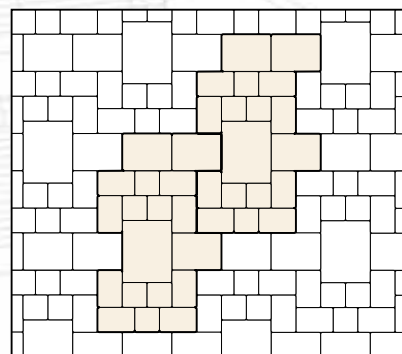

**OLD WORLD**  
16% FLAGSTONE\*  
28% JUMBO  
38% RECTANGLE  
19% SQUARE

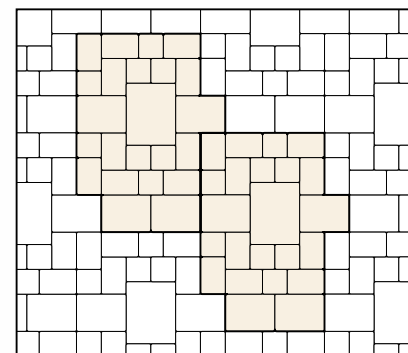

**OLD WORLD II**  
12% FLAGSTONE\*  
30% JUMBO  
38% RECTANGLE  
20% SQUARE

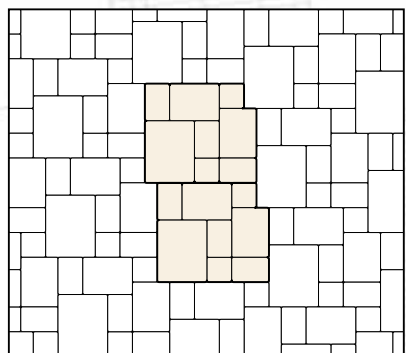

**SHAKE**  
28% FLAGSTONE\*  
34% JUMBO  
26% RECTANGLE  
11% SQUARE

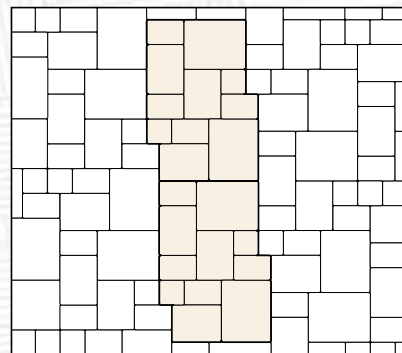

**SILVER DRY**  
37% FLAGSTONE\*  
33% JUMBO  
22% RECTANGLE  
7% SQUARE

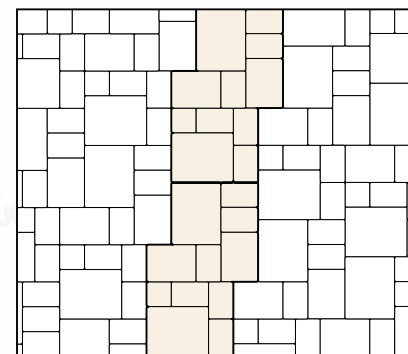

**SPLIT ARROW**  
38% FLAGSTONE\*  
23% JUMBO  
35% RECTANGLE  
4% SQUARE

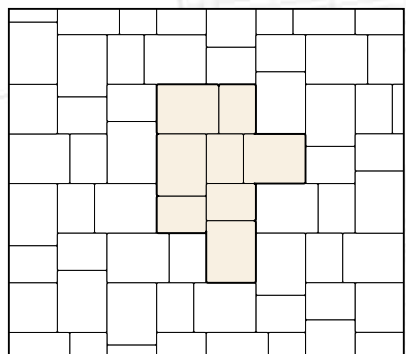

**TOPAZ**  
62% FLAGSTONE\*  
38% JUMBO

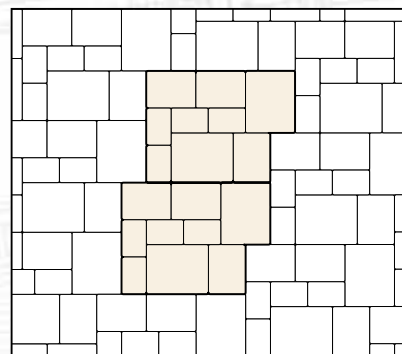

**TRINITY**  
40% FLAGSTONE\*  
36% JUMBO  
24% RECTANGLE

# Specifications

## Standard Interlocking Pavers

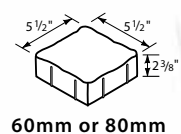

60mm or 80mm

### SQUARE

**Size & Coverage:** 5 1/2" x 5 1/2" x 2 3/8"; 4.74 pcs./ft.<sup>2</sup>  
**Weight:** 5.6 lbs.; Cobblestone is 5.5 lbs.  
**Pallet Coverage:** 108 ft.<sup>2</sup> Cobblestone is 101.  
**Pallet Weight:** approx. 2,966 lbs.

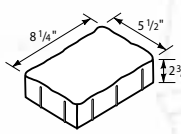

60mm or 80mm

### RECTANGLE

**Size & Coverage:** 8 1/4" x 5 1/2" x 2 3/8"; 3.17 pcs./ft.<sup>2</sup>  
**Weight:** 8.5 lbs.; Cobblestone is 8 lbs.  
**Pallet Coverage:** 101 ft.<sup>2</sup> Cobblestone is 95.  
**Pallet Weight:** approx. 2,610 lbs.

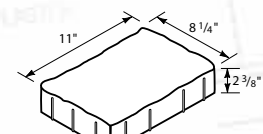

60mm or 80mm

### JUMBO

**Size & Coverage:** 11" x 8 1/4" x 2 3/8"; 1.58 pcs./ft.<sup>2</sup>  
**Weight:** 17.9 lbs.; Cobblestone is 16.5 lbs.  
**Pallet Coverage:** 106 ft.<sup>2</sup> Cobblestone is 101.  
**Pallet Weight:** approx. 3,074 lbs.

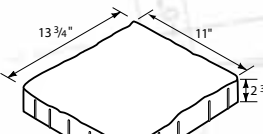

60mm or 80mm

### FLAGSTONE

**Styles:** Not available with Old County Cobble  
**Size & Coverage:** 13 3/4" x 11" x 2 3/8"; .95 pcs./ft.<sup>2</sup>  
**Weight:** 29.5 lbs.  
**Pallet Coverage:** 101 ft.<sup>2</sup>  
**Pallet Weight:** approx. 2,882 lbs.

## Circle Pavers

**Available in:** Slatestone, Slatestone Backside, Cobblestone, Cobblestone Backside and Belgian Cobble.

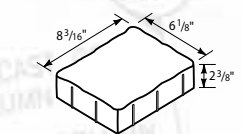

### THREE QUARTER (TQ)

**Styles:** Slatestone, Belgian Cobble, and Cobblestone  
**Size:** 8 3/16" x 6 1/8" x 2 3/8"

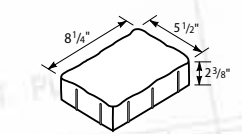

### RECTANGLE (R)

**Styles:** Slatestone, Belgian Cobble, and Cobblestone  
**Size:** 8 1/4" x 5 1/2" x 2 3/8"

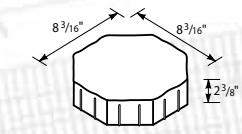

### CENTER (C)

**Styles:** Slatestone, Belgian Cobble, and Cobblestone  
**Size:** 8 3/16" x 8 3/16" x 2 3/8"

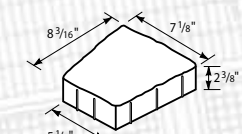

### LARGE CIRCLE WEDGE (LC)

**Styles:** Slatestone, Belgian Cobble, and Cobblestone  
**Size:** 8 3/16" x 7 1/8" x 2 3/8" x 5 1/4"

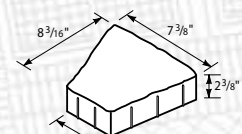

### MEDIUM CIRCLE WEDGE (MC)

**Styles:** Slatestone, Belgian Cobble, and Cobblestone  
**Size:** 8 3/16" x 7 3/8" x 2 3/8" x 4 1/2"

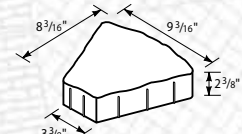

### SMALL CIRCLE WEDGE (SC)

**Styles:** Slatestone, Belgian Cobble, and Cobblestone  
**Size:** 8 3/16" x 9 3/16" x 2 3/8" x 3 3/8"

## Bullnose Pavers

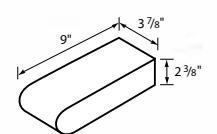

### CLASSIC

**Size & Coverage:** 9" x 3 7/8" x 2 3/8"; 2.8 pcs./ft.<sup>2</sup>  
**Weight:** 6.75 lbs.  
**Pallet Coverage:** 97 ft. lin.  
**Pallet Weight:** approx. 2,085 lbs.

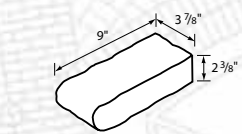

### WEATHERED

**Size & Coverage:** 9" x 3 7/8" x 2 3/8"; 2.8 pcs./ft.<sup>2</sup>  
**Weight:** 6.75 lbs.  
**Pallet Coverage:** 137 ft. lin.  
**Pallet Weight:** approx. 2,930 lbs.

## 1-Inch Pavers (Custom Thicknesses Available)

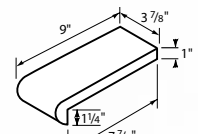

BULLNOSE

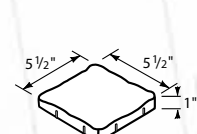

SQUARE

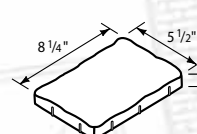

RECTANGLE

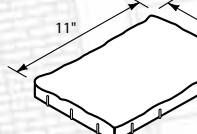

JUMBO

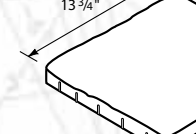

FLAGSTONE

**Composition & Manufacture:** McNear pavers are manufactured from a high strength concrete mix. They conform to ASTM C-936 and have a minimum average compressive strength of 8,000 PSI.

SLATESTONE • SLATESTONE BACKSIDE • COBBLESTONE • PERMEABLE • BELGIAN COBBLE • OLD COUNTY COBBLE • BULLNOSE

SLATESTONE • SLATESTONE BACKSIDE • COBBLESTONE • PERMEABLE • BELGIAN COBBLE • OLD COUNTY COBBLE • BULLNOSE

# Circle Kit Diagram

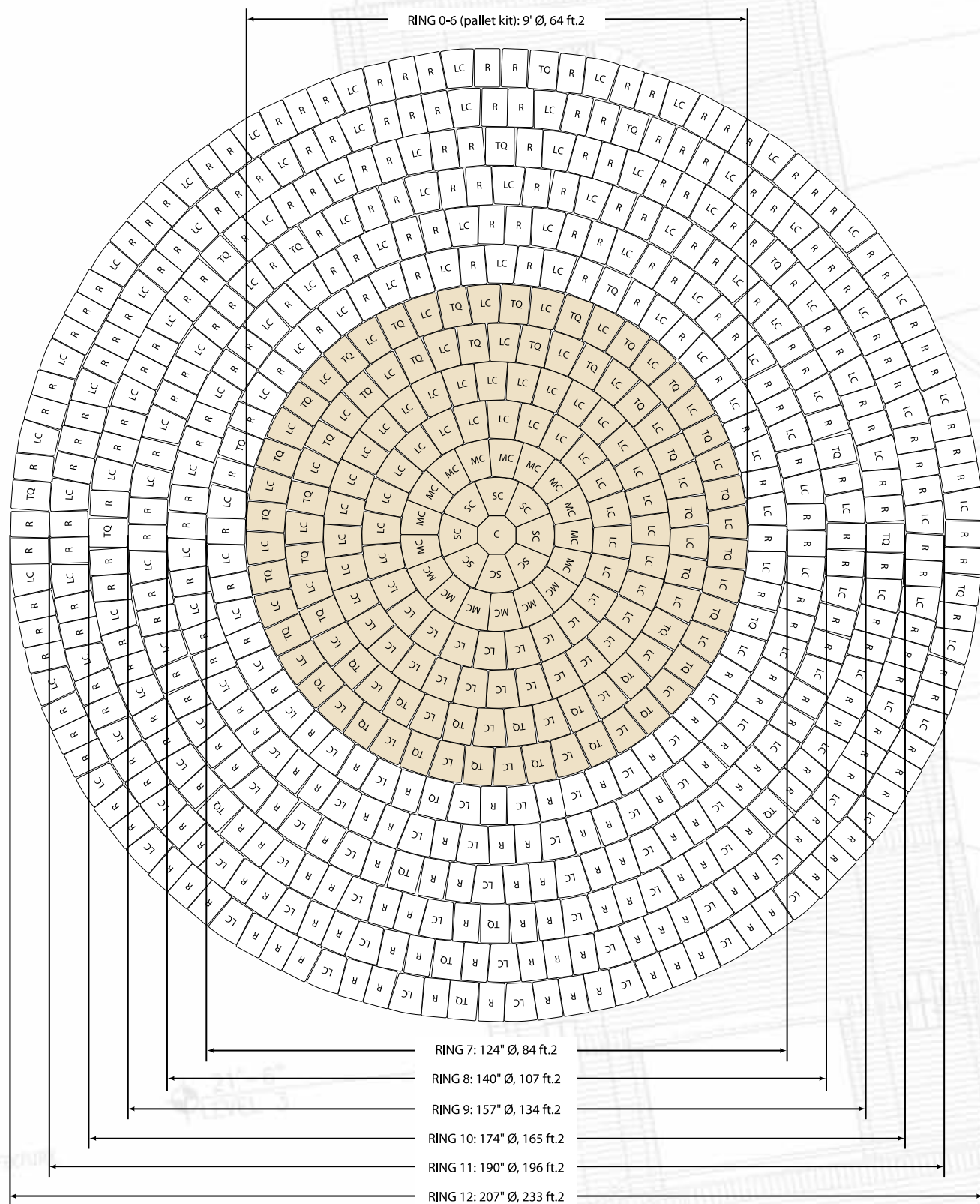

### Circle Paver Pallet Coverage

- Rings 0-6 (pallet kit): 9' diameter and covers 64 sq.ft.
- Ring 7: 124" diameter and covers 84 sq.ft.
- Ring 8: 140" diameter and covers 107 sq.ft.
- Ring 9: 157" diameter and covers 134 sq.ft.
- Ring 10: 174" diameter and covers 165 sq.ft.
- Ring 11: 190" diameter and covers 196 sq.ft.
- Ring 12: 207" diameter and covers 233 sq.ft.

Textures available: Belgian Cobble, Cobblestone and Slatestone.  
 Circle illustration is for conceptual demonstration and is not intended to be followed for technical accuracy.



Slatestone,  
Color: Charcoal/Tan



Slatestone,  
Color: Charcoal/Gray



Slatestone,  
Color: Olive

## Beauty and Sustainability

When we opened our doors in 1868, our workers made bricks by hand and used wheelbarrows to load them onto scow schooners for delivery to the many small ports lining San Francisco Bay.

The days of horse and sail are long gone, but the landmarks built with our products, such as Ghirardelli Square and the Golden Gate Bridge, remain.

Today we manufacture many more products than the clay bricks we started with. McNear is now a leading regional manufacturer of Interlocking Pavers, as well as the VERSA-LOK® family of Segmental Retaining Walls.



## See Our Other Lines of McNear Products

Visit us online at [www.mcnear.com](http://www.mcnear.com) to download or request brochures and samples, and to see our newest colors and products.

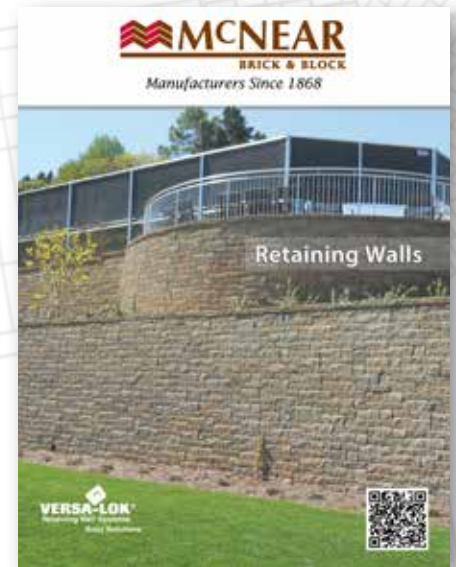
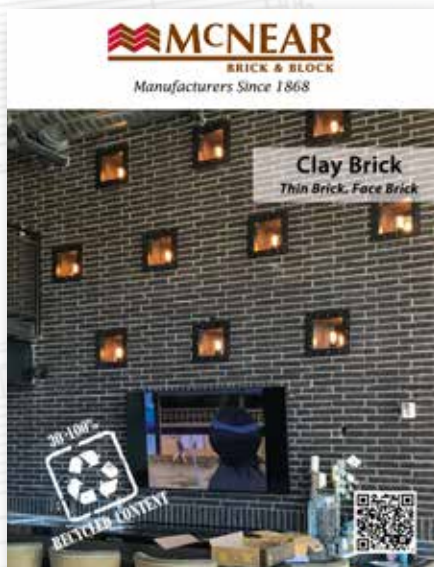

- Thin Brick
- Face Brick
- Interlocking Pavers
- VERSA-LOK® Retaining Walls



1 McNear Brickyard Rd., San Rafael, CA 94901

Phone: 415-454-6811  
Fax: 415-257-6353  
E-mail: [sales@mcnear.com](mailto:sales@mcnear.com)  
[www.mcnear.com](http://www.mcnear.com)